









# MOBILE ACCESSORIES CATALOG

Find accessories for our mobile lubrication systems using this comprehensive catalog.





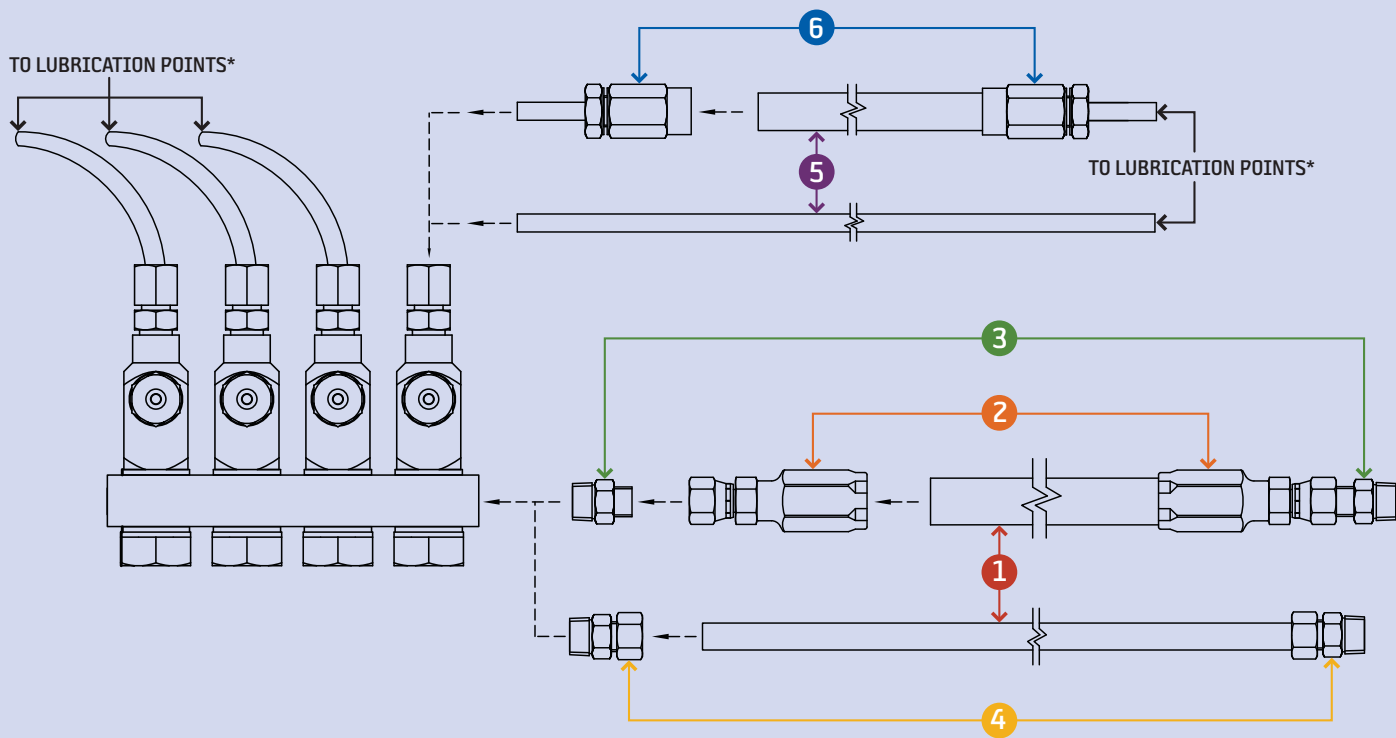

# CXL2 Injectors & Manifolds

	NAME		DESCRIPTION	PART #	NOTES
SUPPLY LINE	1		1/4" I.D. hose (SAE 100R2)	U7184	5800 psi (working pressure)
			3/8" I.D. hose (SAE 100R2)	U7186	4750 psi (working pressure)
			1/2" I.D. hose (SAE 100R2)	U7188	4000 psi (working pressure)
	Tubing		3/8" O.D. stainless steel tubing	7938049304WSS	20' lengths
			3/8" O.D. steel tubing	U424E6	20' lengths
	2		1/4" I.D. hose x female JIC swivel 7/16-20	U43844	Steel
			3/8" I.D. hose x female JIC swivel 9/16-18	U43866	Steel
			1/2" I.D. hose x female JIC swivel 3/4-16	U43888	Steel
	3		JIC 7/16-20 x 1/4" NPT, straight adapter	U43144	Steel
			JIC 7/16-20 x 1/4" NPT, 90° elbow adapter	35528-1	Steel
JIC 9/16-18 x 1/4" NPT, straight adapter			U43146	Steel	
JIC 9/16-18 x 1/4" NPT, 90° elbow adapter			35528-2	Steel	
JIC 3/4-16 x 1/4" NPT, 90° elbow adapter			35528-6	Steel	
JIC 3/4-16 x 3/8" NPT, 90° elbow adapter			35528-7	Steel	
JIC 7/16-20, union tee adapter			35582-1	Steel	
JIC 9/16-18, union tee adapter			35582-2	Steel	
JIC 3/4-16, union tee adapter			35582-3	Steel	
JIC 3/4-16 x 1/4" NPT, straight adapter			U43148	Steel	
JIC 3/4-16 x 3/8" NPT, straight adapter	U43168	Steel			
4	Tubing Adapters		3/8" O.D. tube x 1/4" NPT, straight adapter	U83D2	Steel
			3/8" O.D. tube x 1/4" NPT, 90° elbow adapter	U87D2	Steel
			3/8" O.D. tube union	U84D	Steel
5	Hose		5/32" I.D. flexible hose	34962	For hose end with stand pipe
	Tubing		3/16" O.D. nylon tubing	35449	Black
			(2) tube x 3/16" O.D. nylon bundle	35450	Black & red
			(3) tube x 3/16" O.D. nylon bundle	35451	Black, red & blue
			3/16" O.D. nylon tubing, grease filled NLGI #0	35524	10' lengths
			(2) tube x 3/16" O.D. nylon bundle, grease filled NLGI #0	35453	10' lengths
			(3) tube x 3/16" O.D. nylon bundle, grease filled NLGI #0	35454	10' lengths
			3/16" O.D. nylon tubing, grease filled NLGI #0	35648	15' lengths
			(2) tube x 3/16" O.D. nylon bundle, grease filled NLGI #0	35649	15' lengths
			(3) tube x 3/16" O.D. nylon bundle, grease filled NLGI #0	35650	15' lengths
			3/16" O.D. nylon tubing, grease filled NLGI #0	35601	20' lengths
			(2) tube x 3/16" O.D. nylon bundle, grease filled NLGI #0	35602	20' lengths
			(3) tube x 3/16" O.D. nylon bundle, grease filled NLGI #0	35603	20' lengths
			1/4" O.D. nylon tubing x .050 wall	21672	2500 psi (burst pressure)
	1/4" O.D. nylon tubing x .062 wall	B10437	2000 psi (burst pressure)		
1/4" O.D. nylon tubing x .062 wall, grease filled	35127	25' lengths			
6	Hose Ends		5/32" I.D. hose coupling x 3/16" stand pipe	29116	
			5/32" I.D. hose coupling x 1/4" stand pipe	29117	Order w/ part #27349 & 27341
			5/32" I.D. hose coupling x 1/4" stand pipe 90°	29220	Order w/ part #27349 & 27341



\* SEE PAGES 12-15 FOR TERMINATING FITTINGS & MISCELLANEOUS COMPONENTS

# FLM Injectors



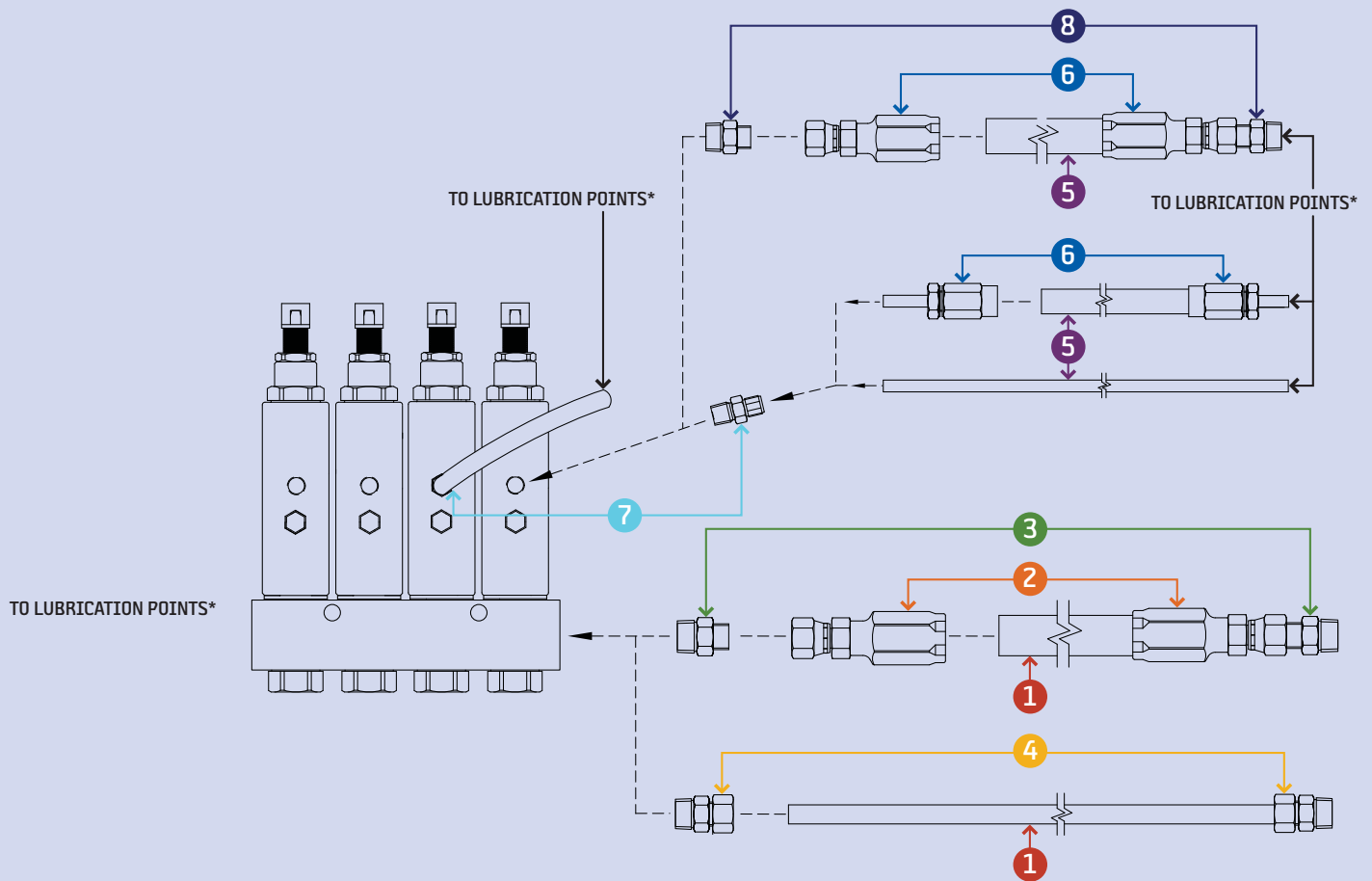



	NAME		DESCRIPTION	PART #	NOTES
SUPPLY LINE	1		1/4" I.D. hose (SAE 100R2)	U7184	5800 psi (working pressure)
			3/8" I.D. hose (SAE 100R2)	U7186	4750 psi (working pressure)
			1/2" I.D. hose (SAE 100R2)	U7188	4000 psi (working pressure)
	Tubing		3/8" O.D. stainless steel tubing	7938049304WSS	20' lengths
			3/8" O.D. steel tubing	U424E6	20' lengths
	2		1/4" I.D. hose x female JIC swivel 7/16-20	U43844	Steel
			3/8" I.D. hose x female JIC swivel 9/16-18	U43866	Steel
			1/2" I.D. hose x female JIC swivel 3/4-16	U43888	Steel
	3		JIC 7/16-20 x 1/4" NPT, straight adapter	U43144	Steel
			JIC 7/16-20 x 3/8" NPT, straight adapter	35575	Steel
			JIC 7/16-20 x 1/4" NPT, 90° elbow adapter	35528-1	Steel
			JIC 7/16-20 x 3/8" NPT, 90° elbow adapter	35528-3	Steel
			JIC 3/4-16 x 1/4" NPT, 90° elbow adapter	35528-6	Steel
			JIC 3/4-16 x 3/8" NPT, 90° elbow adapter	35528-7	Steel
			JIC 9/16-18 x 1/4" NPT, straight adapter	U43146	Steel
			JIC 9/16-18 x 3/8" NPT, straight adapter	U43166	Steel
			JIC 9/16-18 x 1/4" NPT, 90° elbow adapter	35528-2	Steel
			JIC 9/16-18 x 3/8" NPT, 90° elbow adapter	35528-4	Steel
			JIC 7/16-20, union tee adapter	35582-1	Steel
JIC 9/16-18, union tee adapter			35582-2	Steel	
JIC 3/4-16, union tee adapter			35582-3	Steel	
4		1/4" O.D. tube x 1/4" NPT, straight tubing adapter	U83B2	Steel	
		1/4" O.D. tube x 3/8" NPT, straight tubing adapter	U83B3	Steel	
		3/8" O.D. tube x 3/8" NPT, straight tubing adapter	U83D3	Steel	
		3/8" O.D. tube x 1/4" NPT, straight tubing adapter	U83D2	Steel	
		3/8" O.D. tube x 1/4" NPT, 90° elbow tubing adapter	U87D2	Steel	
		3/8" O.D. tube x 3/8" NPT, 90° elbow tubing adapter	U87D3	Steel	
		1/4" O.D. tube x 3/8" NPT, 90° elbow tubing adapter	U87B3	Steel	
		1/4" O.D. tube x 1/4" NPT, 90° elbow tubing adapter	U87B2	Steel	
5		5/32" I.D. flexible hose	34962	For hose end with stand pipe	
		1/4" I.D. hose	35546	Use w/ part #201188	
FEED LINE		3/16" O.D. nylon tubing	35449	Black	
		(2) tube x 3/16" O.D. nylon bundle	35450	Black & red	
		(3) tube x 3/16" O.D. nylon bundle	35451	Black, red & blue	
		3/16" O.D. nylon tubing, grease filled NLGI #0	35524	10' lengths	
		(2) tube x 3/16" O.D. nylon bundle, grease filled NLGI #0	35453	10' lengths	
		(3) tube x 3/16" O.D. nylon bundle, grease filled NLGI #0	35454	10' lengths	
		3/16" O.D. nylon tubing, grease filled NLGI #0	35601	20' lengths	
		(2) tube x 3/16" O.D. nylon bundle, grease filled NLGI #0	35602	20' lengths	
		(3) tube x 3/16" O.D. nylon bundle, grease filled NLGI #0	35603	20' lengths	



\* SEE PAGES 12-15 FOR TERMINATING FITTINGS & MISCELLANEOUS COMPONENTS

FEED LINE	Part Number	Description	Material	Specifications				
				Part Number	Specifications			
5	Tubing	1/4" O.D. nylon tubing x .050 wall	21672	2500 psi (burst pressure)				
		1/4" O.D. nylon tubing x .062 wall	B10437	2000 psi (burst pressure)				
		1/4" O.D. nylon tubing x .062 wall, grease filled	35127	25' lengths				
		6	Hose Ends	5/32" I.D. hose coupling x 3/16" stand pipe	29116			
				5/32" I.D. hose coupling x 1/4" stand pipe	29117			
				5/32" I.D. hose coupling x 1/4" stand pipe 90°	29220			
				1/4" I.D. hose x female JIC swivel 7/16-20	201188	Steel; Use w/ part #35546		
				7	Tubing Adapters	3/16" O.D. tube x 1/8" NPT, 90° tubing adapter	35438	Brass
						3/16" O.D. tube x 1/8" NPT, straight tubing adapter	35435	Brass
		3/16" O.D. tube x 1/8" NPT, straight tubing adapter	U83A1			Steel		
		1/4" O.D. tube x 1/8" NPT, straight tubing adapter	U83B1			Steel		
		3/16" O.D. tube x 1/8" NPT, 90° tubing adapter	U87A1			Steel		
1/4" O.D. tube x 1/8" NPT, 90° tubing adapter	U87B1	Steel						
8	Hose Adapters	JIC 7/16-20 x 1/8" NPT, straight adapter	U43124	Steel				
		JIC 7/16-20 x 1/8" NPT, 90° elbow adapter	35528-5	Steel				

# PVB Divider Valves



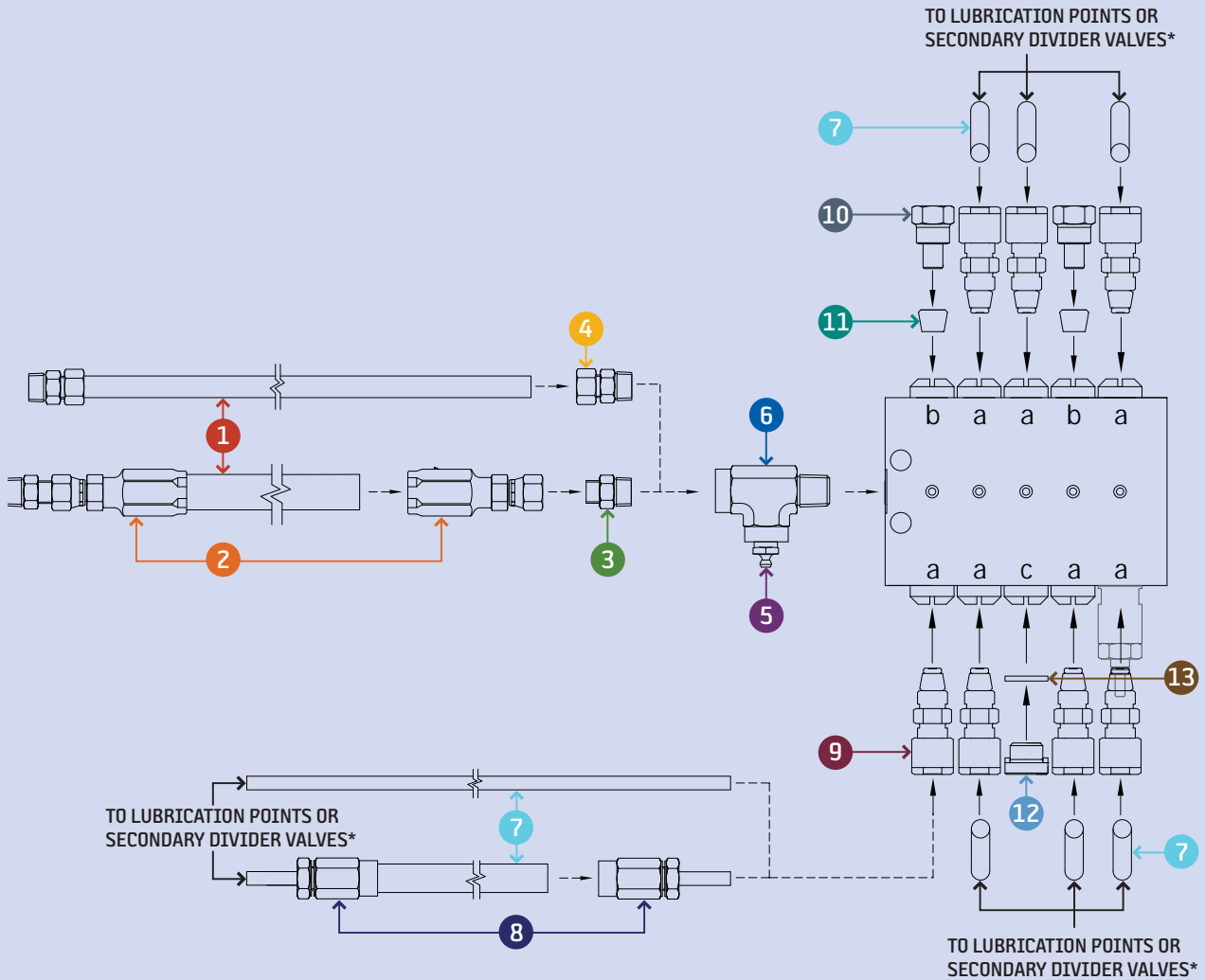





	NAME		DESCRIPTION	PART #	NOTES	
SUPPLY LINE	1		1/4" I.D. hose (SAE 100R2)	U7184	5800 psi (working pressure)	
			3/8" I.D. hose (SAE 100R2)	U7186	4750 psi (working pressure)	
			1/4" I.D. hose (SAE100R7)	35546	3000 psi (working pressure)	
	Tubing		3/8" O.D. stainless steel tubing	7938049304WSS	20' lengths	
			3/8" O.D. steel tubing	U424E6	20' lengths	
	2		1/4" I.D. hose x female JIC swivel 7/16-20	U43844	Steel	
			3/8" I.D. hose x female JIC swivel 9/16-18	U43866	Steel	
			1/4" I.D. hose x female JIC swivel 7/16-20	201188	Steel; Use w/ part #35546	
	3		JIC 7/16-20 x 1/4" NPT, straight adapter	U43144	Steel	
			JIC 7/16-20 x 1/4" NPT, 90° elbow adapter	35528-1	Steel	
			JIC 3/4-16 x 1/4" NPT, 90° elbow adapter	35528-6	Steel	
			JIC 3/4-16 x 3/8" NPT, 90° elbow adapter	35528-7	Steel	
			JIC 7/16-20 x 1/8" NPT, straight adapter	U43124	Steel	
			JIC 9/16-18 x 1/4" NPT, straight adapter	U43146	Steel	
			JIC 9/16-18 x 1/4" NPT, 90° elbow adapter	35528-2	Steel	
			1/4" NPT(F) x 1/8" NPT(M), straight adapter	U1106A	Steel	
4		1/4" O.D. tube x 1/4" NPT, straight tubing adapter	U83B2	Steel		
		1/4" O.D. tube x 1/8" NPT, straight tubing adapter	U83B1	Steel		
		1/4" O.D. tube x 1/4" NPT, 90° elbow tubing adapter	U87B2	Steel		
		1/4" O.D. tube x 1/8" NPT, 90° elbow tubing adapter	U87B1	Steel		
5	Manual Override Fitting		1/8" NPT grease fitting, straight	15332-1		
6	Tee		1/8" NPT(M) x 1/8" NPT(F) x 1/8" NPT(F) male run tee	26978	Steel	
FEED LINE + SECONDARY LINE	7		5/32" I.D. flexible hose	34962	For hose end with stand pipe	
			Tubing	3/16" O.D. nylon tubing	35449	Black
				(2) tube x 3/16" O.D. nylon bundle	35450	Black & red
				(3) tube x 3/16" O.D. nylon bundle	35451	Black, red & blue
				3/16" O.D. nylon bundle-grease filled NLGI #0	35524	10' lengths
				(2) tube x 3/16" O.D. nylon bundle-grease filled NLGI #0	35453	10' lengths
				(3) tube x 3/16" O.D. nylon bundle-grease filled NLGI #0	35454	10' lengths
				3/16" O.D. nylon tubing, grease filled NLGI #0	35601	20' lengths
				(2) tube x 3/16" O.D. nylon bundle, grease filled NLGI #0	35602	20' lengths
				(3) tube x 3/16" O.D. nylon bundle, grease filled NLGI #0	35603	20' lengths
				1/4" O.D. nylon tubing x .050 wall	21672	2500 psi (burst pressure)
1/4" O.D. nylon tubing x .062 wall	B10437	2000 psi (burst pressure)				
1/4" O.D. nylon tubing x .062 wall, grease filled	35127	25' lengths				
8		5/32" I.D. hose coupling x 3/16" stand pipe	29116			
		5/32" I.D. hose coupling x 1/4" stand pipe	29117			
		5/32" I.D. hose coupling x 1/4" stand pipe 90°	29220			



\* SEE PAGES 12-15 FOR TERMINATING FITTINGS & MISCELLANEOUS COMPONENTS

FEED LINE + SECONDARY LINE	9	PVB Outlet Fittings		1/4" O.D. TBG outlet fitting with check valve	35166	Compression
				3/16" O.D. TBG outlet fitting with check valve	35360	Compression
				6mm O.D. TBG outlet fitting with check valve	23301	Compression
				1/4" O.D. TBG outlet fitting QC with check valve	29080	Quick connect; Use w/ Nylon tube
				3/16" O.D. TBG outlet fitting QC with check valve	29084	Quick connect; Use w/ Nylon tube
				6mm O.D. TBG outlet fitting QC with check valve	23407	Quick connect; Use w/ Nylon tube
				1/8" NPT(F) outlet fitting with check valve	29076	Female NPT
				10	Outlet Plug "b"	Closure plug - "b" porting (singling)
11	Clamp Ring "b"	Clamping ring - Required for "b" porting (singling)	73511-3223	Use w/ part #74161-1851		
12	Outlet Plug "c"	Closure plug - "c" porting	74161-5741	Use w/ part #72712-1094		
13	Copper Seal "c"	Copper seal - Required for "c" porting	72712-1094	Use w/ part #74161-5741		

# GXL Injectors & Manifolds





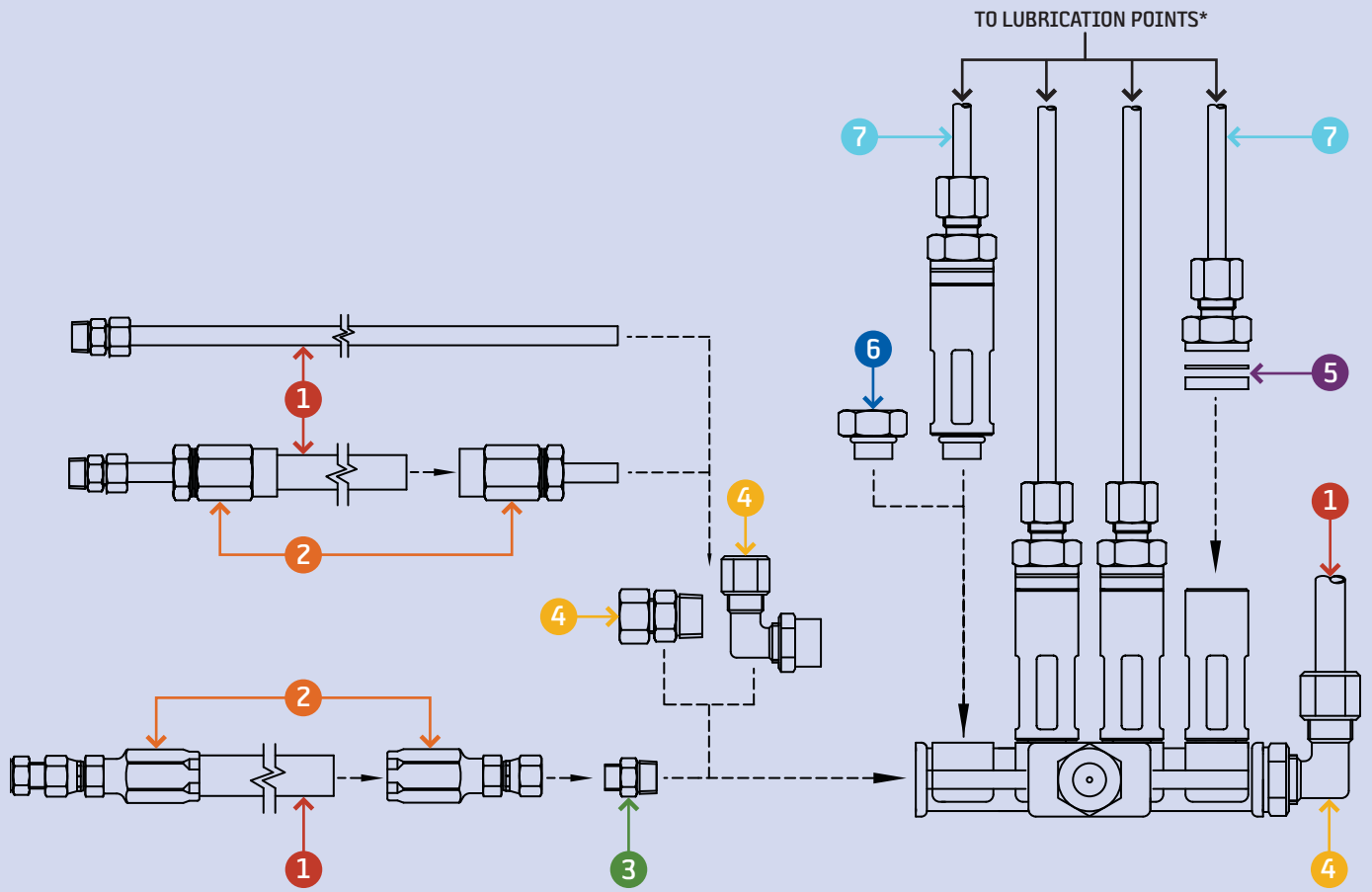



	NAME		DESCRIPTION	PART #	NOTES	
SUPPLY LINE	1	Hose		1/4" I.D. hose (SAE 100R7)	35546	3000 psi (working pressure)
		Tubing		5/16" O.D. nylon tubing	29942	754 psi (working pressure)
	2	Hose Ends		1/4" I.D. hose x female JIC swivel 7/16-20	201188	Steel; Use w/ part #35546
				1/4" I.D. hose coupling x 5/16" stand pipe	34965	
	3	Hose Adapters		JIC 7/16-20 x 1/4" NPT, straight adapter	U43144	Steel
				JIC 7/16-20 x 1/4" NPT, 90° elbow adapter	35528-1	Steel
	4	Tubing Adapters		5/16" O.D. tube x 1/4" NPT, straight tubing adapter	B10090-4	Steel
				5/16" O.D. tube x 1/4" NPT, 90° elbow tubing adapter	B10092-3	Steel
				5/16" O.D. tube x 1/4" NPT, straight tubing adapter	35533	Brass
				5/16" O.D. tube x 1/4" NPT, 90° elbow tubing adapter	35535	Brass
5	Adjustment Washers		3.2mm injector washer	52848-3		
			0.8mm injector washer	52848-1		
6	Port Plug		1/2-24 manifold plug	53355		
			O-ring	22100-11	For unused base ports, Use w/ part #53355	
FEED LINE	7	Tubing		3/16" O.D. nylon tubing	35449	Black
				(2) tube x 3/16" O.D. nylon bundle	35450	Black & red
				(3) tube x 3/16" O.D. nylon bundle	35451	Black, red & blue
				3/16" O.D. nylon tubing-grease filled, NLGI #0	35524	10' lengths
				(2) tube x 3/16" O.D. nylon bundle-grease filled, NLGI #0	35453	10' lengths
				(3) tube x 3/16" O.D. nylon bundle-grease filled, NLGI #0	35454	10' lengths
				3/16" O.D. nylon tubing, grease filled NLGI #0	35601	20' lengths
				(2) tube x 3/16" O.D. nylon bundle, grease filled NLGI #0	35602	20' lengths
(3) tube x 3/16" O.D. nylon bundle, grease filled NLGI #0	35603	20' lengths				





\* SEE PAGES 12-15 FOR TERMINATING FITTINGS & MISCELLANEOUS COMPONENTS

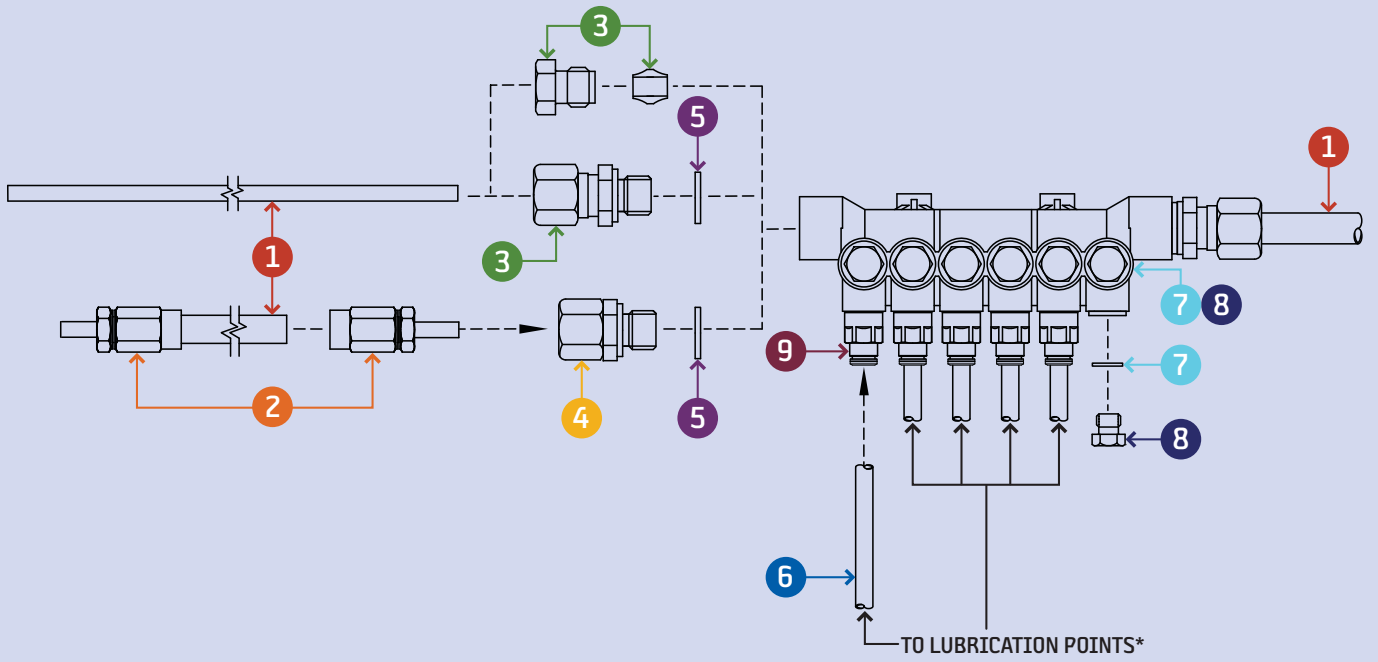

# VXLO Indirect Injectors

	NAME		DESCRIPTION	PART #	NOTES	
SUPPLY LINE	1	Hose		1/4" I.D. hose	35546	3000 psi (working pressure)
		Tubing		10mm O.D. nylon tubing	10N6-BLACK	600 psi (working pressure)
		Union		Connector	53560-1	Connect multiple injectors
	2	Hose Ends		1/4" I.D. hose coupling x 8mm stand pipe	34965	
	3	Tubing Adapters		10mm O.D. tube x M16 x 1.5, straight tubing adapter	AR906	Use w/ part #AR1124
				10mm O.D. tube x M16 x 1.5, banjo 90° tubing adapter	AR137	Use w/ part #AR1124
				10mm O.D. tube x M16 x 1.5, compression bushing	25568	Use w/ part #25677
				10mm O.D. compression sleeve	25677	Use w/ part #25568
		Adapters		M16x1.5 x 1/8NPTF adapter	42444-5	
	4	Adapters		10mm O.D. tube x 8mm O.D. tube	AR806	
5	Copper Washers		M16 x 1.5 copper washer	23483		
FEED LINE	6	Tubing		4mm O.D. nylon tubing	19230	Black
					19230-RD	Red
					19230-BU	Blue
					19230-GN	Green
					19230-YW	Yellow
					19230-BR	Brown
	7	O-rings		Injector plug O-ring	22100-21	Use w/ part #47668
				Outlet O-ring	22100-13	Use w/ part #47673 or #53191
	8	VXLO Plugs		VXLO outlet plug	47673	
VXLO injector plug				47668		
9	Outlet Fitting		VXLO push-to-connect outlet fitting	53191		



\* SEE PAGES 12-15 FOR TERMINATING FITTINGS & MISCELLANEOUS COMPONENTS





# Miscellaneous

TERMINATING FITTINGS				SYSTEM TYPE				
NAME	DESCRIPTION	PART #	NOTES	CXL	FLM	GXL	VXLO	PVB
<b>Tubing Adapter Assembly</b>  	3/16" O.D. tube x 1/8" NPT, 90° elbow tubing adapter	35438	Brass	X	X	X		X
	3/16" O.D. tube x 1/8" NPT, straight tubing adapter	35435	Brass	X	X	X		X
	3/8" O.D. tube x 1/4" NPT(M), tubing adapter	U83D2	Steel			X		
	3/8" O.D. tube x 1/4" NPT(M), 90° elbow tubing adapter	U87D2	Steel			X		
	5/16" O.D. tube x 1/4" NPT, straight tubing adapter	B10090-4	Steel			X		
	5/16" O.D. tube x 1/4" NPT, 90° elbow tubing adapter	B10092-3	Steel			X		
	5/16" O.D. tube x 1/4" NPT, straight tubing adapter	35533	Brass			X		
	5/16" O.D. tube x 1/4" NPT, 90° elbow tubing adapter	35535	Brass			X		
	3/8" O.D. tube x 1/4" NPT, straight tubing adapter	35437	Brass			X		
	3/8" O.D. tube x 1/4" NPT, 90° elbow tubing adapter	35440	Brass			X		
	3/16" O.D. tube x 1/8" NPT, straight tubing adapter	U83A1	Steel	X	X	X		X
	3/16" O.D. tube x 1/4" NPT, straight tubing adapter	U83A2	Steel	X	X	X		X
	1/4" O.D. tube x 1/8" NPT, straight tubing adapter	U83B1	Steel	X	X			X
	1/4" O.D. tube x 1/4" NPT, straight tubing adapter	U83B2	Steel	X	X			X
	3/16" O.D. tube x 1/8" NPT, 90° elbow tubing adapter	U87A1	Steel	X	X	X		
	3/16" O.D. tube x 1/4" NPT, 90° elbow tubing adapter	U87A2	Steel	X	X	X		
	1/4" O.D. tube x 1/8" NPT, 90° elbow tubing adapter	U87B1	Steel	X	X			
	1/4" O.D. tube x 1/4" NPT, 90° elbow tubing adapter	U87B2	Steel	X	X			
	3/16" O.D. tube x 1/4-28, straight tubing adapter	27717 + 35435	Brass/Steel	X	X	X		
	4mm O.D. tube x 1/8" NPT, straight tubing adapter	B3297	Brass				X	
4mm O.D. tube x 1/8" NPT, straight tubing adapter	32995	Steel				X		
4mm O.D. tube x 1/8" NPT, 90° elbow tubing adapter	B3298	Brass				X		
3/16" O.D. tube x 1/8" NPT(F), 90° elbow tubing adapter	35445	Brass	X	X	X		X	
<b>STAINLESS STEEL</b>								
<b>Hose Ends</b>  	1/4" I.D. hose x female JIC swivel 7/16-20	35637-1		X	X			
	3/8" I.D. hose x female JIC swivel 9/16-18	35637-2		X	X			
	1/2" I.D. hose x female JIC swivel 3/4-16	35637-3		X	X			
<b>Hose Adapters (Straight)</b>  	JIC 7/16-20 x 1/4" NPT, straight adapter	35638-1		X	X			
	JIC 9/16-18 x 1/4" NPT, straight adapter	35638-2		X	X			
	JIC 9/16-18 x 1/4" NPT, straight adapter	35638-3		X	X			
	JIC 9/16-18 x 3/8" NPT, straight adapter	35638-4		X	X			
	JIC 7/16-20 x 1/8" NPT, straight adapter	35638-5		X	X			
	JIC 3/4-16 x 1/4" NPT, straight adapter	35638-6		X	X			
	JIC 3/4-16 x 3/8" NPT, straight adapter	35638-7		X	X			
	JIC 9/16-18 x 1/8" NPT, straight adapter	35638-8		X	X			

STAINLESS STEEL				SYSTEM TYPE				
NAME	DESCRIPTION	PART #	NOTES	CXL	FLM	GXL	VXLO	PVB
<b>Hose Adapters (Elbow)</b> 	JIC 7/16-20 x 1/4" NPT, 90° elbow adapter	35636-1		X	X			
	JIC 9/16-18 x 1/4" NPT, 90° elbow adapter	35636-2		X	X			
	JIC 7/16-20 x 3/8" NPT, 90° elbow adapter	35636-3		X	X			
	JIC 9/16-18 x 3/8" NPT, 90° elbow adapter	35636-4		X	X			
	JIC 7/16-20 x 1/8" NPT, 90° elbow adapter	35636-5		X	X			
	JIC 3/4-16 x 1/4" NPT, 90° elbow adapter	35636-6		X	X			
	JIC 3/4-16 x 3/8" NPT, 90° elbow adapter	35636-7		X	X			
	JIC 9/16-18 x 1/8" NPT, 90° elbow adapter	35636-8		X	X			
<b>MISCELLANEOUS COMPONENTS</b>								
<b>Tubing Unions</b> 	1/4" O.D. tube union	U84B	Steel	X	X			X
	3/16" O.D. tube union	35441	Brass	X	X	X		X
	3/8" O.D. tube union	35442	Brass			X		
	5/16" O.D. tube union	35536	Brass			X		
	3/8" O.D. tee tube union	35444	Brass			X		
	4mm O.D. tube union	20657	Brass				X	
	5/16" O.D. tee tube union	35537	Brass			X		
<b>Compression Nuts</b> 	3/16" O.D. tube nut with captive sleeve	35433	Brass	X	X	X		X
	3/8" O.D. tube nut with captive sleeve	35434	Brass			X		
	5/16" O.D. tube nut with captive sleeve	35531	Brass			X		
<b>Adapters</b> 	1/8" NPT x 1/4-28, straight adapter	27717	Steel	X	X	X		X
	1/8" NPT x 1/4-28, 90° adapter	27718	Steel	X	X	X		X
	1/8" NPT x 1/8" NPT, 90° adapter	A2768	Brass	X	X	X		X
	1/8" NPT x 1/8" NPT, 45° adapter	B3133	Brass	X	X	X		X
	1/8" NPT x 1/8" NPT, 90° adapter	U1104AS	Steel	X	X	X		X
	1/4" NPT x 1/4" NPT, 90° adapter	U1104B	Steel	X	X	X		X
	1/8" NPT x 1/8" NPT, 45° adapter	U1103A	Steel	X	X	X		X
	3/8" NPT x 3/8" NPT, 90° adapter	U1104C	Steel	X	X	X		X
	1/4" NPT x 1/4" NPT, 45° adapter	U1103B	Steel	X	X	X		X
	1/8" NPT extension, 3/4" LG	A3920	Brass	X	X	X		X
	1/8" NPT extension, 1-1/4" LG	A2540	Brass	X	X	X		X
	1/8" NPT extension, 3/4" LG	35629-1	Steel	X	X	X		X
	1/8" NPT extension, 1-1/4" LG	35629-2	Steel	X	X	X		X
	1/8" NPT(F) swivel x 1/8" NPT(M)	32382-1	Steel	X	X	X	X	X
	1/4" NPT(F) swivel x 1/4" NPT(M)	35578	Steel	X	X	X	X	X
	1/4" NPT(M) x 1/4" NPT(F) x 1/4" NPT(F) male run tee	19283	Steel	X	X	X		X
	Press on zerk adapter x 1/8" NPT(F)	35160	Steel	X	X	X		X
Zerk adapter w/90° elbow adapter (part #35438)	35160+35438	Steel/Brass	X	X	X		X	
Zerk adapter w/straight adapter (part #35435)	35160+35435	Steel/Brass	X	X	X		X	

# Miscellaneous

MISCELLANEOUS COMPONENTS					SYSTEM TYPE				
NAME	DESCRIPTION	PART #	NOTES	CXL	FLM	GXL	VXLO	PVB	
Plugs		1/8" NPT plug hex head	35573-1	Steel	X	X	X		X
		1/4" NPT plug hex head	35573-2	Steel	X	X	X		X
		3/8" NPT plug	U119CC	Steel		X			
Nipples		3/8" NPT nipple hex	32485-1	Steel	X	X			
		1/4" NPT nipple hex	32485-2	Steel	X	X			
		1/8" NPT nipple hex	32485-3	Steel	X	X			
		1/4" NPT x 1/8" NPT nipple hex	32485-4	Steel	X	X			
Anchor Blocks		1/4" NPT, block (1-1/2" x 1-1/2" x 1")	BLK11689A	9/32" mounting hole	X	X	X		X
		1/8" NPT, block (1-1/2" x 1-1/2" x 1")	BLK11688A	9/32" mounting hole	X	X	X		X
Loom, Straps & Clamps		Heavy duty, nylon, cable tie	24534-1	14" LG	X	X	X	X	X
		Standard duty, nylon, cable tie	HE1132-1	7.3" LG	X	X	X	X	X
		1/4" loom	35419-1		X	X	X	X	X
		1/2" loom	35419-2		X	X	X	X	X
		3/4" loom	35419-3		X	X	X	X	X
		1" loom	35419-4		X	X	X	X	X
		5/8" clamp	35448-4	Use w/ part #U7184	X	X	X	X	X
		3/4" clamp	35448-5	Use w/ part #U7186	X	X	X	X	X
		3/8" clamp	35448-2	Use w/ 3/8" O.D. tube	X	X	X	X	X
		1/4" clamp	35448-1	Use w/ 3/16" O.D. tube	X	X	X	X	X
		1/2" clamp	35448-3	Use w/ 3/16" tube bundles	X	X	X	X	X
1/2" spiral wrap, black		35645	3/8" to 4" bundling range	X	X	X	X	X	
1" spiral wrap, black		35646	1" to 7" bundling range	X	X	X	X	X	
Gauges		5000 psi, 1/4" NPT LM	U902F	Lower mount	X	X			X
		5000 psi, 1/4" NPT CBM	U902FB	Center back mount	X	X			X
		3000 psi, 1/4" NPT LM	U902D	Lower mount			X		
		3000 psi, 1/4" NPT CBM	U902DB	Center back mount			X		
		2000 psi, 1/8" NPT LM	U902J	Lower mount				X	
Pressure Switches		1/4" NPT N.O. set at 600 psi	35517-1			X	X		
		1/4" NPT N.O. set at 2000 psi	35517-2		X	X			X

NAME	DESCRIPTION	PART #	NOTES	CXL	FLM	GXL	VXLO	PVB	
Miscellaneous		Deutsch plug assembly w/ 25' of wire	35559	Use w/ TTN & SMDC	X	X	X		X
		Deutsch plug assembly w/ 25' of wire	35597	Use w/ TTN Controller Ver.	X	X	X		X
		Cable electric SJO 16/4	15117-5		X	X	X	X	X
		LED indicator (12 VDC)	35734-1	(old#35572-1)	X	X	X	X	
		LED indicator (24 VDC)	35734-2	(old#35572-2)	X	X	X	X	
		1/8" NPT grease fitting, straight	15332-1						X
		1/8" NPT grease fitting, 90°	15332-2						X
		1/4" NPT grease fitting, straight	F687						X
		1/4" NPT grease fitting, 65°	F689						X
		1/4" O.D. nylon tubing insert	B144-6		X	X			X
		4mm O.D. nylon tubing insert	22585-1					X	
		10mm O.D. nylon tubing insert	22585-3					X	
Manual Fill Pumps		500 psi fits 120 lb drum	37303		X	X	X	X	X
		fits 35 lb pail	37304		X	X	X	X	X
TTN & MultiPort Accessories		3600 psi relief valve	22474		X	X			X
		3000 psi relief valve	22474-4		X	X			X
		2000 psi relief valve	22474-3						
		1000 psi relief valve	22474-2		X	X			
		TTN 90° mounting plate, Light Duty	35456		X	X			X
		TTN mounting plate, Light Duty	35455		X	X			X
		TTN/DYX 90° mounting plate, Heavy Duty	37433		X	X			X
		TTN /DYX mounting plate, Heavy Duty	37434		X	X			X
		DYN/MP 90° mounting plate	37431		X	X			X
		DYN/MP mounting plate	37432		X	X			X
Grease Guns		Battery-powered grease gun	F4018		X	X	X		X
		Standard Grease Gun	F1205		X	X	X		X
		Manual grease gun - Push Gun*	F40534		X	X	X		X
		Adapter, DYX/MP/TTN - M22x1.5	F80223		X	X	X		X
		Adapter, AERO - 1/4"NPT	37643		X	X	X		X
<p>*F40534 Push Gun allows Pump Reservoirs to be refilled using standard grease cartridges. The Push Gun mates with connector F80223, which can be installed in a spare pump element port (M22x1.5) in pumps such as Dynamis Maxx, MultiPort, and TTN. Adapter 37643 allows connector F80223 to be installed on pumps that have a 1/4" NPT fill port, such as AeroFlow.</p>									

## Innovators of engineered lubrication technology **since 1923**

Bijur Delimon International has ISO 9001:2000 and ISO 14000 quality certified manufacturing facilities around the world, so your centralized lubrication system meets the highest industry quality standards. It's all part of our commitment to quality and customer service.



### GLOBAL HEADQUARTERS

Bijur Delimon International  
2250 Perimeter Park Dr, Suite 120  
Morrisville, NC 27560

(919) 465 4448 **LOCAL**  
(800) 631 0168 **TOLL-FREE**  
(919) 465 0516 **FAX**

[WWW.BIJURDELIMON.COM/MOBILE](http://WWW.BIJURDELIMON.COM/MOBILE)

**35544 • R11 09/13**